

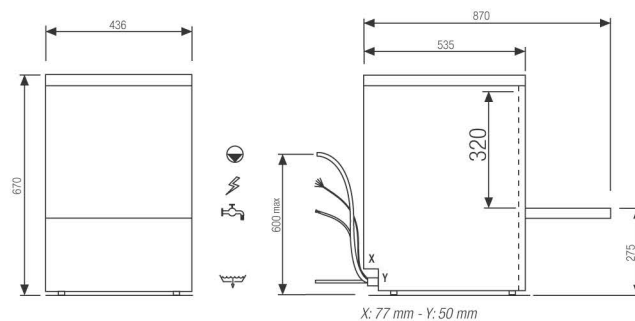



EW 540



Model - Modelo - Modello	Cod.	€
EW 540	917706	
EW 540S	917707	
EW 540DP	917908	
EW 540R	917907	







Standard Equipment - Equipamiento - Dotazioni		Cod.
	n. 2	780133
	n. 1	780139
	n. 1+1 (round rack version - versión cesta redonda versione con cesto rotondo)	983060 983015

* S: water softener - suavizador de agua - addolcitore

** DP: peristaltic detergent dispenser and drain pump - dosi cador de detergente peristáltico y bomba de desagüe - dosatore detergente peristaltico e pompa scarico

*** R: round rack version - versión cesta redonda - versione con cesto rotondo

Technical data - Datos técnicos - Dati tecnici

Dimension - Dimensiones - Dimensioni		cm	43.6x53.5x67
Door opening height - Altura puerta - Apertura porta		cm	32
Dish max. height - Altura máxima plato - Altezza max piatto		cm	30
Glass max. height - Altura máxima vaso - Altezza max bicchiere		cm	30
Washing cycle - Ciclo de lavado - Ciclo di lavaggio		sec.	120
Rack - Cesta - Cesto		cm	39x39 - Ø39
Water consumption - Consumo de agua - Consumo acqua		L/cycle - L/ciclo - L/ciclo	1.7
Wash pump - Bomba propulsora - Pompa di lavaggio		kW	0.2
		L	8
Tank - Cuba - Vasca		kW	0.6
		°C	60
		L	2.6
Booster - Calderín - Boiler		kW	2.6
		°C	65
Peristaltic rinse dispenser - Dosificador peristáltico de abrillantador - Dosatore brillantante peristaltico			√

Optional	Cod.	€	Installed power Potencia instalada - Potenza Installata	Amp.	kW
Drain pump Bomba de desagüe - Pompa scarico	999354		230 V - 50 Hz - 1N	16	3.5
Detergent dispenser Dosificador de detergente - Dosatore detergente	999347		Available - Disponible - Disponibile		
			230 V - 60 Hz - 1N	16	3.5